

Conax Technologies Model PL (Power Lead) Glands seal on insulated leadwire for use in transformers, motors, conduit boxes and pressure/vacuum chambers and as power or instrument feedthroughs. The soft sealant technology seals against gases or liquids and resists element movement under pressure. Immersion length adjustments and easy replacement of elements can be accomplished in the field.

PL glands may be purchased with or without wire. If supplied with wire, solid copper wire with Kapton® insulation is standard. This is provided as 24" total with the gland centered at mid-point. Standard sealants are Grafoil or PTFE. Other materials for wire and sealants can be provided for special applications. Consult your Conax Technologies sales engineer for more information on available options.

Terminals can be furnished on all wire ends if specified, at additional cost. Bulk wire is available from Conax Technologies for field assembly of PL glands. (See the Accessories Section, page 102.)

PL gland bodies with NPT threads and SAE threads are constructed from 303SST standard. Weld-neck style gland bodies are constructed from 316LSST standard. Caps and followers for all styles are constructed from 303SST standard. Many optional materials are also available, including 316LSST, Monel 405, Hastelloy C276, Inconel and more. For information on alternative materials, see page 9. Cap Style A offers a mounting thread only. Cap Style B provides threading on both ends for attachment to conduit or terminal heads.

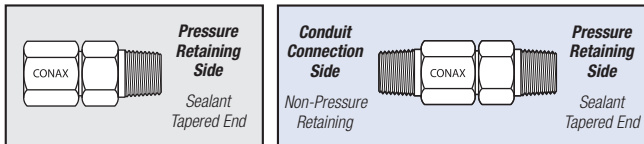

Type A has mounting thread only.

Type B has cap end threaded. B Cap NPT matches the standard mounting NPT.

Alternative sealant materials are available. Please consult a Conax Technologies sales engineer for custom needs.

- Temperature Range: -300° F to +450° F (-185° C to +232° C)
- Pressure Range: Vacuum to 10,000 PSIG (690 bar) – see Pressure Ratings in Specifications Chart.
- 600 Volts to 55 amps
- Seals 1-18 Wires
- Easy installation – no “potting”
- Wire Identification Markers applied
- Thermocouple Material conductors available, 18 gauge standard, other wire gauges optional

Accessories

The replaceable sealant permits repeated use of the same fitting. Assembly is simple and may be done in the field. Simply insert the elements and torque the cap. To replace the sealant or elements, simply loosen the cap, replace the necessary items, relubricate and retorque the cap.

Glands are supplied factory lubricated. When reused, the glands should be relubricated to maintain the published torque and pressure ratings. If glands are cleaned prior to assembly, they should be relubricated. On weld mount models, the heat from the welding process will destroy the lubricant. These models must be relubricated prior to use. See page 103 for information on our lubrication kit.

Replacement Packing Sets are available. These consist of a sealant and two insulators. Replacement sealants may also be ordered separately.

To order a Replacement Packing Set, order
RPS – (Gland) – (Wire Gauge) – (Number of Holes) – (Sealant)

Example: RPS-PL-12-3-T

To order a Replacement Sealant only, order
RS – (Gland) – (Wire Gauge) – (Number of Holes) – (Sealant)

Example: RS-PL-12-3-T

Catalog Numbering System

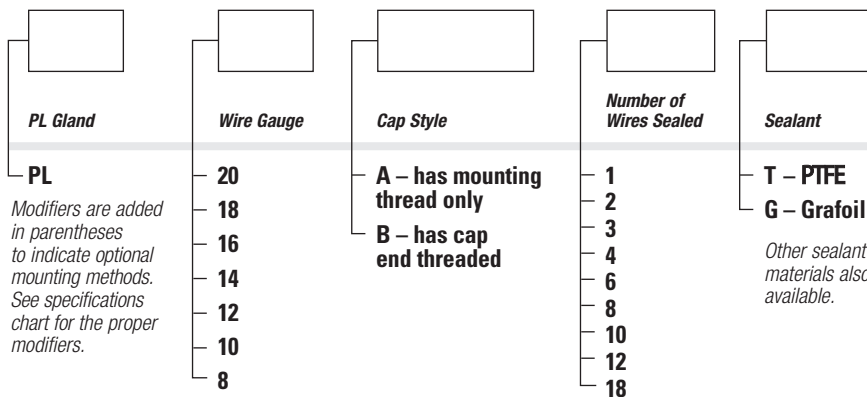

PL Gland
Wire Gauge
Cap Style
Number of Wires Sealed
Sealant
Wire Length
Cap Style
Wire Length Body Side

Example: PL-12-A3-T, 24/36

(With Non-Standard Wire Length)

Example: PL-12-A3-T

(With Standard Wire Length)

Example: PL-18(J)-A2-T, 24/36

(With Thermocouple Material Conductors)

Example: PL-12-A3-T-XX

(Without Conductors)

INSULATED LEADWIRE (POWER LEAD) SEALING ■ PL SERIES

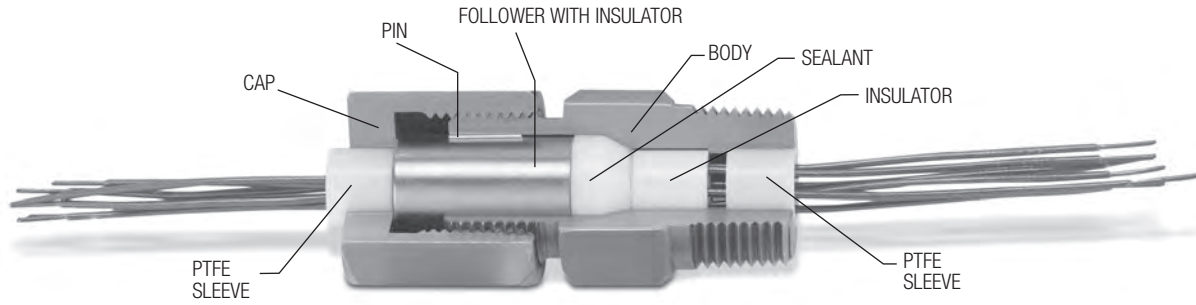

PL Selection Guide

Wire Gauge	Standard Number of Wires Offered								
	1	2	3	4	6	8	10	12	18
20		X	X	X	X	X			X
18	X	X	X	X	X	X	X	X	
16		X	X	X	X	X	X	X	
14	X	X	X	X	X	X	X	X	
12		X	X	X	X				
10		X	X	X					
8		X	X						

The number of wires offered is dependent on the mounting port size. See the Specifications charts on the subsequent pages for details.

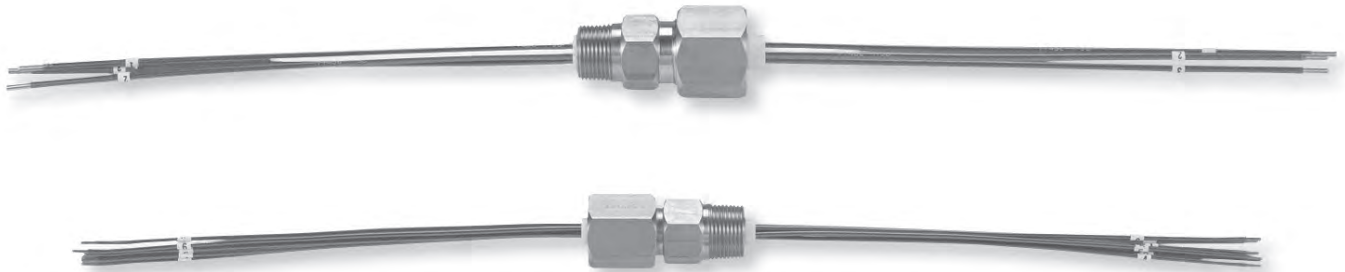

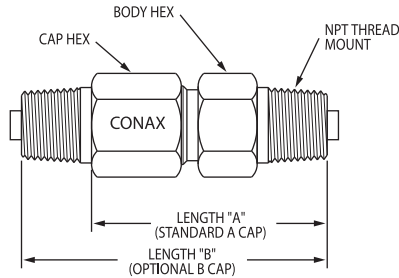

Standard NPT

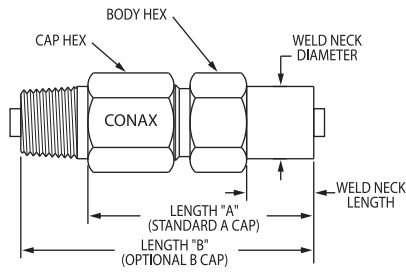

Weld Neck Mount

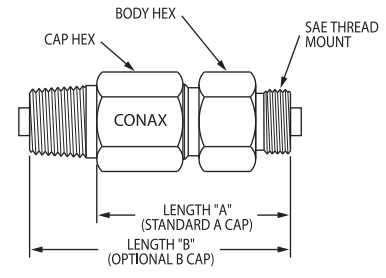

SAE Thread Mount

Catalog Number	Wire Gauge	Number of Wires	Amperage Rating Per Wire	Length 'A'		Length 'B'		Hex Size				Pressure Rating			
				IN	MM	IN	MM	Body IN	Cap IN	Body MM	Cap MM	Grafoil PSIG	BAR	PTFE PSIG	BAR
Standard 1/8 NPT															
PL-18-1	18	1	13	1.38	35.1	1.75	44.5	0.500	0.563	12.7	14.3	10,000	689	1,600	110
PL-14-1	14	1	24	1.38	35.1	1.75	44.5	0.500	0.563	12.7	14.3	10,000	689	800	55
Weld Neck (Weld Neck Length 0.39, Diameter 0.405)															
PL(SWM1/S316L)-18-1	18	1	13	1.38	35.1	1.75	44.5	0.500	0.563	12.7	14.3	10,000	689	1,600	110
PL(SWM1/S316L)-14-1	14	1	24	1.38	35.1	1.75	44.5	0.500	0.563	12.7	14.3	10,000	689	800	55
SAE 7/16 -20 Thread Mount (formerly MS)															
PL(MSE4)-18-1	18	1	13	1.70	43.2	2.06	52.3	0.688	0.563	17.5	14.3	9,138	630	1,600	110
PL(MSE4)-14-1	14	1	24	1.70	43.2	2.06	52.3	0.688	0.563	17.5	14.3	9,138	630	800	55
Standard 1/2 NPT															
PL-20-2	20	2	9	2.63	66.7	3.38	85.7	1.000	1.000	25.4	25.4	10,000	689	5,000	345
PL-20-3	20	3	9	2.63	66.7	3.38	85.7	1.000	1.000	25.4	25.4	10,000	689	5,000	345
PL-20-4	20	4	9	2.63	66.7	3.38	85.7	1.000	1.000	25.4	25.4	10,000	689	5,000	345
PL-18-2	18	2	13	2.63	66.7	3.38	85.7	1.000	1.000	25.4	25.4	10,000	689	4,000	276
PL-18-3	18	3	13	2.63	66.7	3.38	85.7	1.000	1.000	25.4	25.4	10,000	689	4,000	276
PL-18-4	18	4	13	2.63	66.7	3.38	85.7	1.000	1.000	25.4	25.4	10,000	689	4,000	276
PL-16-2	16	2	17	2.63	66.7	3.38	85.7	1.000	1.000	25.4	25.4	10,000	689	3,000	207
PL-16-3	16	3	17	2.63	66.7	3.38	85.7	1.000	1.000	25.4	25.4	10,000	689	3,000	207
PL-16-4	16	4	17	2.63	66.7	3.38	85.7	1.000	1.000	25.4	25.4	10,000	689	3,000	207
PL-14-2	14	2	24	2.63	66.7	3.38	85.7	1.000	1.000	25.4	25.4	10,000	689	1,500	103
PL-14-3	14	3	24	2.88	73.0	3.63	92.1	1.125	1.250	28.6	31.8	10,000	689	2,000	138
PL-14-4	14	4	24	2.88	73.0	3.63	92.1	1.125	1.250	28.6	31.8	10,000	689	1,600	110
Optional 1/4 NPT															
PL(PTM2)-20-2	20	2	9	2.63	66.7	3.38	85.7	1.000	1.000	25.4	25.4	10,000	689	5,000	345
PL(PTM2)-20-3	20	3	9	2.63	66.7	3.38	85.7	1.000	1.000	25.4	25.4	10,000	689	5,000	345
PL(PTM2)-20-4	20	4	9	2.63	66.7	3.38	85.7	1.000	1.000	25.4	25.4	10,000	689	5,000	345
PL(PTM2)-18-2	18	2	13	2.63	66.7	3.38	85.7	1.000	1.000	25.4	25.4	10,000	689	4,000	276
PL(PTM2)-18-3	18	3	13	2.63	66.7	3.38	85.7	1.000	1.000	25.4	25.4	10,000	689	4,000	276
PL(PTM2)-18-4	18	4	13	2.63	66.7	3.38	85.7	1.000	1.000	25.4	25.4	10,000	689	4,000	276
PL(PTM2)-16-2	16	2	17	2.63	66.7	3.38	85.7	1.000	1.000	25.4	25.4	10,000	689	3,000	207
PL(PTM2)-16-3	16	3	17	2.63	66.7	3.38	85.7	1.000	1.000	25.4	25.4	10,000	689	3,000	207
PL(PTM2)-16-4	16	4	17	2.63	66.7	3.38	85.7	1.000	1.000	25.4	25.4	10,000	689	3,000	207
PL(PTM2)-14-2	14	2	24	2.63	66.7	3.38	85.7	1.000	1.000	25.4	25.4	10,000	689	1,500	103

Note: the pressure and torque ratings provided in this catalog apply only when bores are drilled by Conax Technologies.

* Hex size for the body and cap are the same unless a cap size is provided in parentheses.

** Weld neck models require lubrication prior to use.

5001D

INSULATED LEADWIRE (POWER LEAD) SEALING ■ PL SERIES

Catalog Number	Amperage			Length 'A'		Length 'B'		Hex Size				Pressure Rating			
	Wire Gauge	Number of Wires	Rating Per Wire	IN	MM	IN	MM	Body IN	Cap IN	Body MM	Cap MM	Grafoil		PTFE	
												PSIG	BAR	PSIG	BAR
Weld Neck (Weld Neck Length 0.78", Diameter 0.840")															
PL(SWM4/S316L)-20-2	20	2	9	2.63	66.7	3.38	85.7	1.000	1.000	25.4	25.4	10,000	689	5,000	345
PL(SWM4/S316L)-20-3	20	3	9	2.63	66.7	3.38	85.7	1.000	1.000	25.4	25.4	10,000	689	5,000	345
PL(SWM4/S316L)-20-4	20	4	9	2.63	66.7	3.38	85.7	1.000	1.000	25.4	25.4	10,000	689	5,000	345
PL(SWM4/S316L)-18-2	18	2	13	2.63	66.7	3.38	85.7	1.000	1.000	25.4	25.4	10,000	689	4,000	276
PL(SWM4/S316L)-18-3	18	3	13	2.63	66.7	3.38	85.7	1.000	1.000	25.4	25.4	10,000	689	4,000	276
PL(SWM4/S316L)-18-4	18	4	13	2.63	66.7	3.38	85.7	1.000	1.000	25.4	25.4	10,000	689	4,000	276
PL(SWM4/S316L)-16-2	16	2	17	2.63	66.7	3.38	85.7	1.000	1.000	25.4	25.4	10,000	689	3,000	207
PL(SWM4/S316L)-16-3	16	3	17	2.63	66.7	3.38	85.7	1.000	1.000	25.4	25.4	10,000	689	3,000	207
PL(SWM4/S316L)-16-4	16	4	17	2.63	66.7	3.38	85.7	1.000	1.000	25.4	25.4	10,000	689	3,000	207
PL(SWM4/S316L)-14-2	14	2	24	2.63	66.7	3.38	85.7	1.000	1.000	25.4	25.4	10,000	689	1,500	103
PL(SWM4/S316L)-14-3	14	3	24	2.88	73.0	3.63	92.1	1.125	1.250	28.6	31.8	10,000	689	2,000	138
PL(SWM4/S316L)-14-4	14	4	24	2.88	73.0	3.63	92.1	1.125	1.250	28.6	31.8	10,000	689	1,600	110
SAE 3/4-16 Thread Mount (formerly MS)															
PL(MSE8)-20-2	20	2	9	2.63	66.7	3.38	85.7	1.000	1.000	25.4	25.4	9,138	630	5,000	345
PL(MSE8)-20-3	20	3	9	2.63	66.7	3.38	85.7	1.000	1.000	25.4	25.4	9,138	630	5,000	345
PL(MSE8)-20-4	20	4	9	2.63	66.7	3.38	85.7	1.000	1.000	25.4	25.4	9,138	630	5,000	345
PL(MSE8)-18-2	18	2	13	2.63	66.7	3.38	85.7	1.000	1.000	25.4	25.4	9,138	630	4,000	276
PL(MSE8)-18-3	18	3	13	2.63	66.7	3.38	85.7	1.000	1.000	25.4	25.4	9,138	630	4,000	276
PL(MSE8)-18-4	18	4	13	2.63	66.7	3.38	85.7	1.000	1.000	25.4	25.4	9,138	630	4,000	276
PL(MSE8)-16-2	16	2	17	2.63	66.7	3.38	85.7	1.000	1.000	25.4	25.4	9,138	630	3,000	207
PL(MSE8)-16-3	16	3	17	2.63	66.7	3.38	85.7	1.000	1.000	25.4	25.4	9,138	630	3,000	207
PL(MSE8)-16-4	16	4	17	2.63	66.7	3.38	85.7	1.000	1.000	25.4	25.4	9,138	630	3,000	207
PL(MSE8)-14-2	14	2	24	2.63	66.7	3.38	85.7	1.000	1.000	25.4	25.4	9,138	630	1,500	103
SAE 7/8-14 Thread Mount (formerly MS)															
PL(MSE10)-14-3	14	3	24	2.88	73.0	3.63	92.1	1.125	1.250	28.6	31.8	7,600	524	2,000	138
PL(MSE10)-14-4	14	4	24	2.88	73.0	3.63	92.1	1.125	1.250	28.6	31.8	7,600	524	1,600	110
Standard 3/4 NPT															
PL-20-6	20	6	9	2.88	73.0	3.63	92.1	1.125	1.250	28.6	31.8	10,000	689	3,200	220
PL-20-8	20	8	9	2.88	73.0	3.63	92.1	1.125	1.250	28.6	31.8	10,000	689	3,200	220
PL-20-18	20	18	9	2.88	73.0	3.63	92.1	1.250	1.500	31.8	38.1	10,000	689	2,400	165
PL-18-6	18	6	13	2.88	73.0	3.63	92.1	1.125	1.250	28.6	31.8	10,000	689	2,700	186
PL-18-8	18	8	13	2.88	73.0	3.63	92.1	1.125	1.250	28.6	31.8	10,000	689	2,700	186
PL-18-10	18	10	13	2.88	73.0	3.63	92.1	1.250	1.500	31.8	38.1	10,000	689	2,100	145
PL-18-12	18	12	13	2.88	73.0	3.63	92.1	1.250	1.500	31.8	38.1	10,000	689	2,100	145
PL-16-6	16	6	17	2.88	73.0	3.63	92.1	1.125	1.250	28.6	31.8	10,000	689	2,700	186
PL-16-8	16	8	17	2.88	73.0	3.63	92.1	1.125	1.250	28.6	31.8	10,000	689	2,700	186
PL-16-10	16	10	17	2.88	73.0	3.63	92.1	1.250	1.500	31.8	38.1	10,000	689	1,700	117
PL-16-12	16	12	17	2.88	73.0	3.63	92.1	1.250	1.500	31.8	38.1	10,000	689	1,700	117
PL-14-6	14	6	24	2.88	73.0	3.63	92.1	1.125	1.250	28.6	31.8	10,000	689	1,600	110
PL-14-8	14	8	24	2.88	73.0	3.63	92.1	1.125	1.250	28.6	31.8	10,000	689	1,600	110
PL-14-10	14	10	24	2.88	73.0	3.63	92.1	1.250	1.500	31.8	38.1	10,000	689	1,400	96
PL-14-12	14	12	24	2.88	73.0	3.63	92.1	1.250	1.500	31.8	38.1	10,000	689	1,400	96
PL-12-2	12	2	30	2.88	73.0	3.63	92.1	1.125	1.250	28.6	31.8	8,800	606	1,200	83
PL-12-3	12	3	30	2.88	73.0	3.63	92.1	1.125	1.250	28.6	31.8	8,800	606	1,200	83
PL-12-4	12	4	30	2.88	73.0	3.63	92.1	1.125	1.250	28.6	31.8	8,800	606	1,200	83
PL-12-6	12	6	30	2.88	73.0	3.63	92.1	1.125	1.250	28.6	31.8	8,800	606	1,200	83
PL-10-2	10	2	40	2.88	73.0	3.63	92.1	1.125	1.250	28.6	31.8	8,000	551	1,200	83
PL-10-3	10	3	40	2.88	73.0	3.63	92.1	1.125	1.250	28.6	31.8	8,000	551	1,200	83
PL-10-4	10	4	40	2.88	73.0	3.63	92.1	1.125	1.250	28.6	31.8	8,000	551	1,200	83
PL-8-2	8	2	55	2.88	73.0	3.63	92.1	1.125	1.250	28.6	31.8	8,000	551	800	55
PL-8-3	8	3	55	2.88	73.0	3.63	92.1	1.250	1.500	31.8	38.1	8,000	551	800	55

All pressure and torque ratings were determined at 68° F (20° C) using solid Kapton-insulated copper conductors as the element. Pressure ratings may degrade at higher temperatures. Pressure rating guide values are provided for glands with elements restrained by the compressed sealant. Higher pressure may be attained with additional element restraints. Tolerance of tube or probe diameter is ±0.005. Deviation from the nominal may affect pressure ratings.

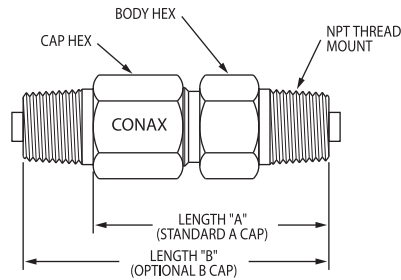

Standard NPT

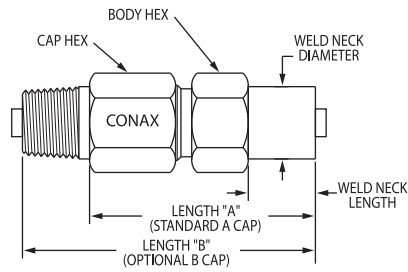

Weld Neck Mount

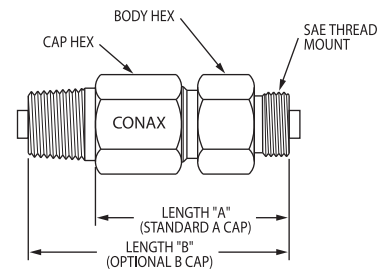

SAE Thread Mount

Catalog Number	Wire Gauge	Number of Wires	Amperage Rating Per Wire	Length 'A'		Length 'B'		Hex Size				Pressure Rating			
				IN	MM	IN	MM	Body IN	Cap IN	Body MM	Cap MM	Grafoil PSIG	BAR	PTFE PSIG	BAR
Optional 1/2 NPT															
PL(PTM4)-20-6	20	6	9	2.88	73.0	3.63	92.1	1.125	1.250	28.6	31.8	10,000	689	3,200	220
PL(PTM4)-20-8	20	8	9	2.88	73.0	3.63	92.1	1.125	1.250	28.6	31.8	10,000	689	3,200	220
PL(PTM4)-18-6	18	6	13	2.88	73.0	3.63	92.1	1.125	1.250	28.6	31.8	10,000	689	2,700	186
PL(PTM4)-18-8	18	8	13	2.88	73.0	3.63	92.1	1.125	1.250	28.6	31.8	10,000	689	2,700	186
PL(PTM4)-16-6	16	6	17	2.88	73.0	3.63	92.1	1.125	1.250	28.6	31.8	10,000	689	2,700	186
PL(PTM4)-16-8	16	8	17	2.88	73.0	3.63	92.1	1.125	1.250	28.6	31.8	10,000	689	2,700	186
PL(PTM4)-14-6	14	6	24	2.88	73.0	3.63	92.1	1.125	1.250	28.6	31.8	10,000	689	1,600	110
PL(PTM4)-14-8	14	8	24	2.88	73.0	3.63	92.1	1.125	1.250	28.6	31.8	10,000	689	1,600	110
PL(PTM4)-12-2	12	2	30	2.88	73.0	3.63	92.1	1.125	1.250	28.6	31.8	8,800	606	1,200	83
PL(PTM4)-12-3	12	3	30	2.88	73.0	3.63	92.1	1.125	1.250	28.6	31.8	8,800	606	1,200	83
PL(PTM4)-12-4	12	4	30	2.88	73.0	3.63	92.1	1.125	1.250	28.6	31.8	8,800	606	1,200	83
PL(PTM4)-12-6	12	6	30	2.88	73.0	3.63	92.1	1.125	1.250	28.6	31.8	8,800	606	1,200	83
PL(PTM4)-10-2	10	2	40	2.88	73.0	3.63	92.1	1.125	1.250	28.6	31.8	8,000	551	1,200	83
PL(PTM4)-10-3	10	3	40	2.88	73.0	3.63	92.1	1.125	1.250	28.6	31.8	8,000	551	1,200	83
PL(PTM4)-10-4	10	4	40	2.88	73.0	3.63	92.1	1.125	1.250	28.6	31.8	8,000	551	1,200	83
PL(PTM4)-8-2	8	2	55	2.88	73.0	3.63	92.1	1.125	1.250	28.6	31.8	8,000	551	800	55
Weld Neck (Weld Neck Length 0.79", Diameter 1.050")															
PL(SWM5/S316L)-20-6	20	6	9	2.88	73.0	3.63	92.1	1.125	1.250	28.6	31.8	10,000	689	3,200	220
PL(SWM5/S316L)-20-8	20	8	9	2.88	73.0	3.63	92.1	1.125	1.250	28.6	31.8	10,000	689	3,200	220
PL(SWM5/S316L)-20-18	20	18	9	2.88	73.0	3.63	92.1	1.250	1.500	31.8	38.1	10,000	689	2,400	165
PL(SWM5/S316L)-18-6	18	6	13	2.88	73.0	3.63	92.1	1.125	1.250	28.6	31.8	10,000	689	2,700	186
PL(SWM5/S316L)-18-8	18	8	13	2.88	73.0	3.63	92.1	1.125	1.250	28.6	31.8	10,000	689	2,700	186
PL(SWM5/S316L)-18-10	18	10	13	2.88	73.0	3.63	92.1	1.250	1.500	31.8	38.1	10,000	689	2,100	145
PL(SWM5/S316L)-18-12	18	12	13	2.88	73.0	3.63	92.1	1.250	1.500	31.8	38.1	10,000	689	2,100	145
PL(SWM5/S316L)-16-6	16	6	17	2.88	73.0	3.63	92.1	1.125	1.250	28.6	31.8	10,000	689	2,700	186
PL(SWM5/S316L)-16-8	16	8	17	2.88	73.0	3.63	92.1	1.125	1.250	28.6	31.8	10,000	689	2,700	186
PL(SWM5/S316L)-16-10	16	10	17	2.88	73.0	3.63	92.1	1.250	1.500	31.8	38.1	10,000	689	1,700	117
PL(SWM5/S316L)-16-12	16	12	17	2.88	73.0	3.63	92.1	1.250	1.500	31.8	38.1	10,000	689	1,700	117
PL(SWM5/S316L)-14-6	14	6	24	2.88	73.0	3.63	92.1	1.125	1.250	28.6	31.8	10,000	689	1,600	110
PL(SWM5/S316L)-14-8	14	8	24	2.88	73.0	3.63	92.1	1.125	1.250	28.6	31.8	10,000	689	1,600	110
PL(SWM5/S316L)-14-10	14	10	24	2.88	73.0	3.63	92.1	1.250	1.500	31.8	38.1	10,000	689	1,400	96
PL(SWM5/S316L)-14-12	14	12	24	2.88	73.0	3.63	92.1	1.250	1.500	31.8	38.1	10,000	689	1,400	96
PL(SWM5/S316L)-12-2	12	2	30	2.88	73.0	3.63	92.1	1.125	1.250	28.6	31.8	8,800	606	1,200	83
PL(SWM5/S316L)-12-3	12	3	30	2.88	73.0	3.63	92.1	1.125	1.250	28.6	31.8	8,800	606	1,200	83
PL(SWM5/S316L)-12-4	12	4	30	2.88	73.0	3.63	92.1	1.125	1.250	28.6	31.8	8,800	606	1,200	83
PL(SWM5/S316L)-12-6	12	6	30	2.88	73.0	3.63	92.1	1.125	1.250	28.6	31.8	8,800	606	1,200	83
PL(SWM5/S316L)-10-2	10	2	40	2.88	73.0	3.63	92.1	1.125	1.250	28.6	31.8	8,000	551	1,200	83
PL(SWM5/S316L)-10-3	10	3	40	2.88	73.0	3.63	92.1	1.125	1.250	28.6	31.8	8,000	551	1,200	83
PL(SWM5/S316L)-10-4	10	4	40	2.88	73.0	3.63	92.1	1.125	1.250	28.6	31.8	8,000	551	1,200	83
PL(SWM5/S316L)-8-2	8	2	55	2.88	73.0	3.63	92.1	1.125	1.250	28.6	31.8	8,000	551	800	55
PL(SWM5/S316L)-8-3	8	3	55	2.88	73.0	3.63	92.1	1.250	1.500	31.8	38.1	8,000	551	800	55

Catalog Number	Wire Gauge	Number of Wires	Amperage Rating Per Wire	Length 'A'		Length 'B'		Hex Size				Pressure Rating					
				IN	MM	IN	MM	Body IN	Cap IN	Body MM	Cap MM	Grafoil		PTFE			
														PSIG	BAR	PSIG	BAR
SAE 7/8 -14 Thread Mount (formerly MS)																	
PL(MSE10)-20-6	20	6	9	2.88	73.0	3.63	92.1	1.125	1.250	28.6	31.8	7,600	524	3,200	220		
PL(MSE10)-20-8	20	8	9	2.88	73.0	3.63	92.1	1.125	1.250	28.6	31.8	7,600	524	3,200	220		
PL(MSE10)-18-6	18	6	13	2.88	73.0	3.63	92.1	1.125	1.250	28.6	31.8	7,600	524	2,700	186		
PL(MSE10)-18-8	18	8	13	2.88	73.0	3.63	92.1	1.125	1.250	28.6	31.8	7,600	524	2,700	186		
PL(MSE10)-16-6	16	6	17	2.88	73.0	3.63	92.1	1.125	1.250	28.6	31.8	7,600	524	2,700	186		
PL(MSE10)-16-8	16	8	17	2.88	73.0	3.63	92.1	1.125	1.250	28.6	31.8	7,600	524	2,700	186		
PL(MSE10)-14-6	14	6	24	2.88	73.0	3.63	92.1	1.125	1.250	28.6	31.8	7,600	524	1,600	110		
PL(MSE10)-14-8	14	8	24	2.88	73.0	3.63	92.1	1.125	1.250	28.6	31.8	7,600	524	1,600	110		
PL(MSE10)-12-2	12	2	30	2.88	73.0	3.63	92.1	1.125	1.250	28.6	31.8	7,600	524	1,200	83		
PL(MSE10)-12-3	12	3	30	2.88	73.0	3.63	92.1	1.125	1.250	28.6	31.8	7,600	524	1,200	83		
PL(MSE10)-12-4	12	4	30	2.88	73.0	3.63	92.1	1.125	1.250	28.6	31.8	7,600	524	1,200	83		
PL(MSE10)-12-6	12	6	30	2.88	73.0	3.63	92.1	1.125	1.250	28.6	31.8	7,600	524	1,200	83		
PL(MSE10)-10-2	10	2	40	2.88	73.0	3.63	92.1	1.125	1.250	28.6	31.8	7,600	524	1,200	83		
PL(MSE10)-10-3	10	3	40	2.88	73.0	3.63	92.1	1.125	1.250	28.6	31.8	7,600	524	1,200	83		
PL(MSE10)-10-4	10	4	40	2.88	73.0	3.63	92.1	1.125	1.250	28.6	31.8	7,600	524	1,200	83		
PL(MSE10)-8-2	8	2	55	2.88	73.0	3.63	92.1	1.125	1.250	28.6	31.8	7,600	524	800	55		

Catalog Number	Wire Gauge	Number of Wires	Amperage Rating Per Wire	Length 'A'		Length 'B'		Hex Size				Pressure Rating					
				IN	MM	IN	MM	Body IN	Cap IN	Body MM	Cap MM	Grafoil		PTFE			
														PSIG	BAR	PSIG	BAR
SAE 1-5/16 -12 Thread Mount (formerly MS)																	
PL(MSE16)-20-18	20	18	9	2.88	73.0	3.63	92.1	1.625	1.500	41.3	38.1	5,802	400	2,400	165		
PL(MSE16)-18-10	18	10	13	2.88	73.0	3.63	92.1	1.625	1.500	41.3	38.1	5,802	400	2,100	145		
PL(MSE16)-18-12	18	12	13	2.88	73.0	3.63	92.1	1.625	1.500	41.3	38.1	5,802	400	2,100	145		
PL(MSE16)-16-10	16	10	17	2.88	73.0	3.63	92.1	1.625	1.500	41.3	38.1	5,802	400	1,700	117		
PL(MSE16)-16-12	16	12	17	2.88	73.0	3.63	92.1	1.625	1.500	41.3	38.1	5,802	400	1,700	117		
PL(MSE16)-14-10	14	10	24	2.88	73.0	3.63	92.1	1.625	1.500	41.3	38.1	5,802	400	1,400	96		
PL(MSE16)-14-12	14	12	24	2.88	73.0	3.63	92.1	1.625	1.500	41.3	38.1	5,802	400	1,400	96		
PL(MSE16)-8-3	8	3	55	2.88	73.0	3.63	92.1	1.625	1.500	41.3	38.1	5,802	400	800	55		

* Hex size for the body and cap are the same unless a cap size is provided in parentheses.

** Weld neck models require lubrication prior to use.

All pressure and torque ratings were determined at 68° F (20° C) using solid Kapton-insulated copper conductors as the element. Pressure ratings may degrade at higher temperatures. Pressure rating guide values are provided for glands with elements restrained by the compressed sealant. Higher pressure may be attained with additional element restraints. Tolerance of tube or probe diameter is ±0.005. Deviation from the nominal may affect pressure ratings.