

Conax Technologies Model PG Packing Glands provide pressure/vacuum sealing for tubes, probes, pipe, cable or any single element assembly (not electrically isolating), including thermocouples, RTDs, thermometers, thermistor probes, capillary tubes, tubewells, multi-pair cables and analyzer sample tubes. PG glands seal against gases and liquids and resist element movement under pressure.

PG gland bodies with NPT threads or SAE threads are constructed from 303SST standard. Weld-neck style gland bodies are constructed from 316LSST standard. Caps and followers for all styles are constructed from 303SST standard. Many optional materials are also available, including 316LSST, Monel 405, Hastelloy C276, Inconel and more. For information on alternative materials, see page 9. Cap Style A offers a mounting thread only. Cap Style B provides threading on both ends for attachment to conduit or terminal heads.

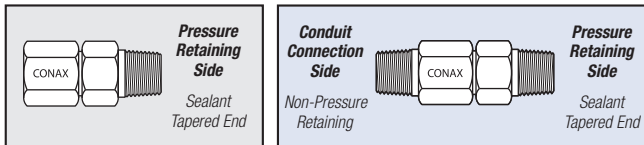

Type A has mounting thread only.

Type B has cap end threaded. B Cap NPT matches the standard mounting NPT.

Alternative sealant materials and custom bore sizes are available. Please consult a Conax Technologies sales engineer for custom needs.

- Temperature Range: -400° F to +1600° F (-240° C to +870° C), depending on sealant used. See page 8 for details.
- Pressure Range: Vacuum to 10,000 PSIG (690 bar) – see Pressure Ratings in Specifications Chart.

Accessories

The replaceable sealant permits repeated use of the same fitting. Assembly is simple and may be done in the field. Simply insert the element and torque the cap. To replace the sealant and/or element, simply loosen the cap, replace the necessary items, relubricate and retorque the cap.

Glands are supplied factory lubricated. When reused, the glands should be relubricated to maintain published torque and pressure ratings. If glands are cleaned prior to assembly, they should be relubricated. On weld mount models, the heat from the welding process will destroy the lubricant. These models must also be relubricated prior to use. See page 103 for information on our lubrication kit.

To order Replacement Sealant, order RS - (Gland) - (Diameter) - (Sealant)

Example: RS-MPG-125-V

Catalog Numbering System

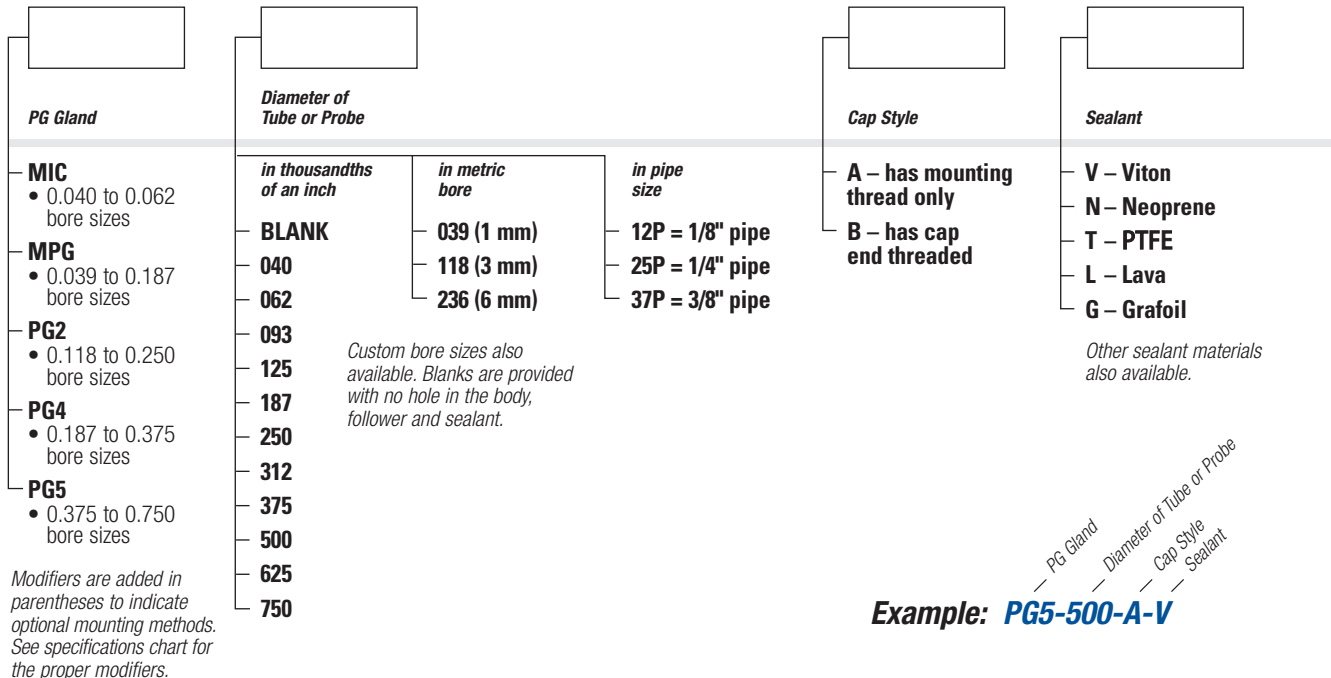

Note: These glands are available with flanges. See pages 80-101 for flange options.

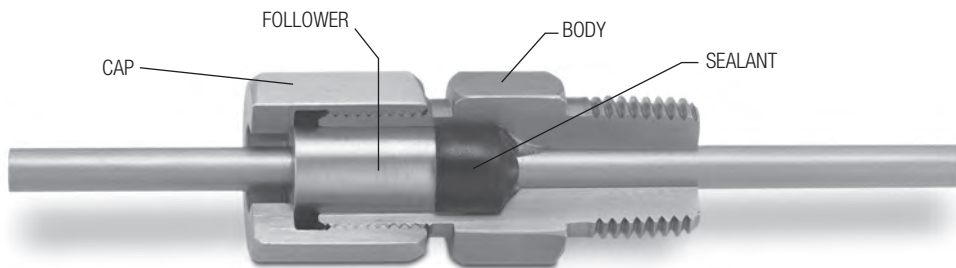

PG Selection Guide

Model	NPT Size*	Bore Diameter																		
		BLANK	039	040	062	093	118	125	187	236	250	312	375	12P	500	25P	625	37P	750	
MIC	1/16			X	X															
MPG	1/8	X	X	X	X	X	X	X	X											
PG2	1/4	X					X	X	X	X	X									
PG4	1/2	X						X	X	X	X	X	X							
PG5	3/4	X											X	X	X	X	X	X	X	X

*These are the standard mounting ports for these models. Optional reduced mounting ports may also be available. See the Specifications Charts on the subsequent pages for details.

Sealant Selection Guide

Material	Temperature Range
Lava (L)	-300° F to +1600° F (-185° C to +870° C)
PTFE (T)	-300° F to +450° F (-185° C to +232° C)
Neoprene (N)	-40° F to +200° F (-40° C to +93° C)
Viton (V)	-10° F to +450° F (-23° C to +232° C)
Grafoil (G)	-400° F to +925° F in air, +3000° F in inert or reducing atm. (-240° C to +495° C in air, +1650° C in inert or reducing atm.)



NEW! Process Analyzer Sample Probe Assembly (SPA) with a Conax Packing (PG) Compression Seal Fitting

The Conax Technologies Sample Probe Assembly (SPA) utilizes a Conax PG Gland to hot-tap a probe into a process through a process isolation valve. See page 78 of this catalog for details on this assembly.

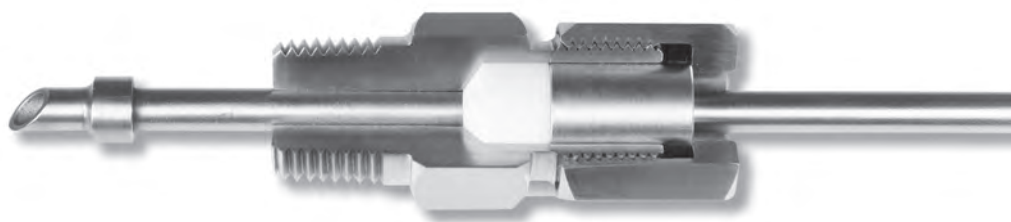

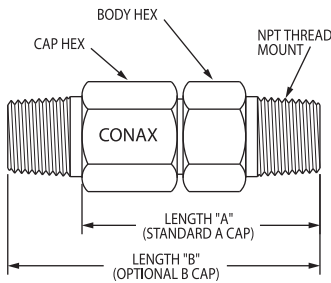

Standard NPT

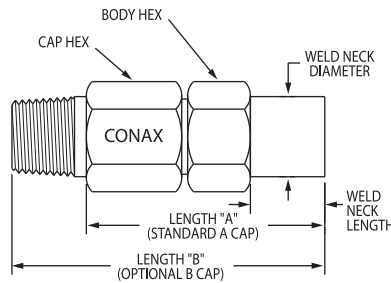

Weld Neck Mount

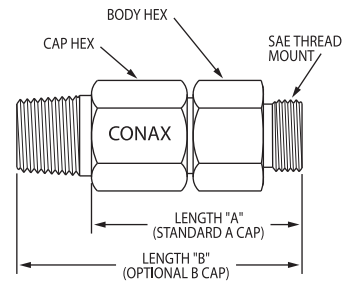

SAE Thread Mount

Catalog Number	Tube/Probe Diameter		Length 'A'		Length 'B'		Hex Size				Pressure Rating										
	IN	MM	IN	MM	IN	MM	Body IN	Cap IN	Body MM	Cap MM	Neoprene PSIG	Neoprene BAR	Viton PSIG	Viton BAR	PTFE ¹ PSIG	PTFE ¹ BAR	Lava PSIG	Lava BAR	Grafoil PSIG	Grafoil BAR	
BORE SIZES 0.040 TO 0.062 - MODEL MIC																					
Standard 1/16 NPT																					
MIC-040	0.040	1.02	0.94	23.8	NA	NA	0.375	0.343	9.5	8.7	NA	NA	NA	NA	3,200	220	8,000	551	NA	NA	
MIC-062	0.062	1.57	0.94	23.8	NA	NA	0.375	0.343	9.5	8.7	NA	NA	NA	NA	3,200	220	8,000	551	10,000	689	
BORE SIZES 0.039 TO 0.187 - MODEL MPG																					
Standard 1/8 NPT																					
MPG-BLANK	NA	NA	1.19	30.2	1.56	39.7	0.500	0.500	12.7	12.7	NA	NA	NA	NA	NA	NA	NA	NA	NA	NA	
MPG-039	0.039	0.99	1.19	30.2	1.56	39.7	0.500	0.500	12.7	12.7	2,000	138	1,600	110	1,600	110	2,800	193	1,600	110	
MPG-040	0.040	1.02	1.19	30.2	1.56	39.7	0.500	0.500	12.7	12.7	2,000	138	1,600	110	1,600	110	2,800	193	1,600	110	
MPG-062	0.062	1.57	1.19	30.2	1.56	39.7	0.500	0.500	12.7	12.7	1,600	110	2,800	193	1,600	110	3,200	220	2,000	138	
MPG-093	0.093	2.36	1.19	30.2	1.56	39.7	0.500	0.500	12.7	12.7	1,200	83	1,200	83	800	55	2,000	138	2,400	165	
MPG-118	0.118	3.00	1.19	30.2	1.56	39.7	0.500	0.500	12.7	12.7	1,200	83	1,200	83	800	55	2,000	138	2,400	165	
MPG-125	0.125	3.18	1.19	30.2	1.56	39.7	0.500	0.500	12.7	12.7	1,200	83	1,200	83	800	55	2,000	138	2,400	165	
MPG-187	0.187	4.75	1.19	30.2	1.56	39.7	0.500	0.500	12.7	12.7	1,200	83	1,500	103	1,500	103	2,000	138	800	55	
Weld Neck Mount (Weld Neck Length 0.39", Diameter 0.405")**																					
MPG(SWM1/S316L)-BLANK	NA	NA	1.19	30.2	1.56	39.7	0.500	0.500	12.7	12.7	NA	NA	NA	NA	NA	NA	NA	NA	NA	NA	
MPG(SWM1/S316L)-039	0.039	0.99	1.19	30.2	1.56	39.7	0.500	0.500	12.7	12.7	2,000	138	1,600	110	1,600	110	2,800	193	1,600	110	
MPG(SWM1/S316L)-040	0.040	1.02	1.19	30.2	1.56	39.7	0.500	0.500	12.7	12.7	2,000	138	1,600	110	1,600	110	2,800	193	1,600	110	
MPG(SWM1/S316L)-062	0.062	1.57	1.19	30.2	1.56	39.7	0.500	0.500	12.7	12.7	1,600	110	2,800	193	1,600	110	3,200	220	2,000	138	
MPG(SWM1/S316L)-093	0.093	2.36	1.19	30.2	1.56	39.7	0.500	0.500	12.7	12.7	1,200	83	1,200	83	800	55	2,000	138	2,400	165	
MPG(SWM1/S316L)-118	0.118	3.00	1.19	30.2	1.56	39.7	0.500	0.500	12.7	12.7	1,200	83	1,200	83	800	55	2,000	138	2,400	165	
MPG(SWM1/S316L)-125	0.125	3.18	1.19	30.2	1.56	39.7	0.500	0.500	12.7	12.7	1,200	83	1,200	83	800	55	2,000	138	2,400	165	
MPG(SWM1/S316L)-187	0.187	4.75	1.19	30.2	1.56	39.7	0.500	0.500	12.7	12.7	1,200	83	1,500	103	1,500	103	2,000	138	800	55	
SAE 3/8-24 Thread Mount (formerly MS)																					
MPG(MSE3)-BLANK	NA	NA	1.19	30.2	1.56	39.7	0.625	0.500	15.9	12.7	NA	NA	NA	NA	NA	NA	NA	NA	NA	NA	
MPG(MSE3)-040	0.040	1.02	1.19	30.2	1.56	39.7	0.625	0.500	15.9	12.7	2,000	138	1,600	110	1,600	110	2,800	193	1,600	110	
MPG(MSE3)-062	0.062	1.57	1.19	30.2	1.56	39.7	0.625	0.500	15.9	12.7	1,600	110	2,800	193	1,600	110	3,200	220	2,000	138	
SAE 7/16-20 Thread Mount (formerly MS)																					
MPG(MSE4)-BLANK	NA	NA	1.25	31.8	1.63	41.3	0.688	0.500	17.5	12.7	NA	NA	NA	NA	NA	NA	NA	NA	NA	NA	
MPG(MSE4)-093	0.093	2.36	1.25	31.8	1.63	41.3	0.688	0.500	17.5	12.7	1,200	83	1,200	83	800	55	2,000	138	2,400	165	
MPG(MSE4)-125	0.125	3.18	1.25	31.8	1.63	41.3	0.688	0.500	17.5	12.7	1,200	83	1,200	83	800	55	2,000	138	2,400	165	
SAE 1/2-20 Thread Mount (formerly MS)																					
MPG(MSE5)-BLANK	NA	NA	1.25	31.8	1.63	41.3	0.750	0.500	19.1	12.7	NA	NA	NA	NA	NA	NA	NA	NA	NA	NA	
MPG(MSE5)-187	0.187	4.75	1.25	31.8	1.63	41.3	0.750	0.500	19.1	12.7	1,200	83	1,500	103	1,500	103	2,000	138	800	55	

Note: the pressure and torque ratings provided in this catalog apply only when bores are drilled by Conax Technologies.

* Hex size for the body and cap are the same unless a cap size is provided in parentheses. Blanks are provided with no hole in the body, follower and sealant.

** Weld neck models require lubrication prior to use.

N/O = Not Offered, NA = Not Applicable

5001D

SINGLE ELEMENT SEALING – SPECIFICATIONS ■ PG SERIES

Catalog Number	Tube/Probe Diameter		Length 'A'		Length 'B'		Hex Size				Pressure Rating									
	IN	MM	IN	MM	IN	MM	Body IN	Cap IN	Body MM	Cap MM	Neoprene PSIG	Neoprene BAR	Viton PSIG	Viton BAR	PTFE PSIG	PTFE BAR	Lava PSIG	Lava BAR	Grafoil PSIG	Grafoil BAR
BORE SIZES 0.118 TO 0.250 - MODEL PG2																				
Standard 1/4 NPT																				
PG2-BLANK	NA	NA	2.00	50.8	2.63	66.7	0.750	0.750	19.1	19.1	NA	NA	NA	NA	NA	NA	NA	NA	NA	NA
PG2-118	0.118	3.00	2.00	50.8	2.63	66.7	0.750	0.750	19.1	19.1	2,800	193	2,800	193	1,600	110	9,000	620	8,000	551
PG2-125	0.125	3.18	2.00	50.8	2.63	66.7	0.750	0.750	19.1	19.1	2,800	193	2,800	193	1,600	110	9,000	620	8,000	551
PG2-187	0.187	4.75	2.00	50.8	2.63	66.7	0.750	0.750	19.1	19.1	2,000	138	4,500	310	1,600	110	8,800	606	4,000	276
PG2-236	0.236	5.99	2.00	50.8	2.63	66.7	0.750	0.750	19.1	19.1	1,800	124	3,000	207	1,200	83	7,500	517	4,000	276
PG2-250	0.250	6.35	2.00	50.8	2.63	66.7	0.750	0.750	19.1	19.1	1,600	110	2,000	138	800	55	7,500	517	4,000	276
PG2 with Optional 1/8 NPT																				
PG2(PTM1)-118	0.118	3.00	2.00	50.8	2.63	66.7	0.750	0.750	19.1	19.1	2,800	193	2,800	193	1,600	110	9,000	620	8,000	551
PG2(PTM1)-125	0.125	3.18	2.00	50.8	2.63	66.7	0.750	0.750	19.1	19.1	2,800	193	2,800	193	1,600	110	9,000	620	8,000	551
PG2(PTM1)-187	0.187	4.75	2.00	50.8	2.63	66.7	0.750	0.750	19.1	19.1	2,000	138	4,500	310	1,600	110	8,800	606	4,000	276
PG2(PTM1)-236	0.236	5.99	2.00	50.8	2.63	66.7	0.750	0.750	19.1	19.1	1,800	124	3,000	207	1,200	83	7,500	517	4,000	276
PG2(PTM1)-250	0.250	6.35	2.00	50.8	2.63	66.7	0.750	0.750	19.1	19.1	1,600	110	2,000	138	800	55	7,500	517	4,000	276
PG2 with Optional 3/8 NPT																				
PG2(PTM3)-118	0.118	3.00	2.00	50.8	2.63	66.7	0.750	0.750	19.1	19.1	2,800	193	2,800	193	1,600	110	9,000	620	8,000	551
PG2(PTM3)-125	0.125	3.18	2.00	50.8	2.63	66.7	0.750	0.750	19.1	19.1	2,800	193	2,800	193	1,600	110	9,000	620	8,000	551
PG2(PTM3)-187	0.187	4.75	2.00	50.8	2.63	66.7	0.750	0.750	19.1	19.1	2,000	138	4,500	310	1,600	110	8,800	606	4,000	276
PG2(PTM3)-236	0.236	5.99	2.00	50.8	2.63	66.7	0.750	0.750	19.1	19.1	1,800	124	3,000	207	1,200	83	7,500	517	4,000	276
PG2(PTM3)-250	0.250	6.35	2.00	50.8	2.63	66.7	0.750	0.750	19.1	19.1	1,600	110	2,000	138	800	55	7,500	517	4,000	276
Weld Neck Mount (Weld Neck Length 0.59", Diameter 0.540")**																				
PG2(SWM2/S316L)-BLANK	NA	NA	2.00	50.8	2.63	66.7	0.750	0.750	19.1	19.1	NA	NA	NA	NA	NA	NA	NA	NA	NA	NA
PG2(SWM2/S316L)-118	0.118	3.00	2.00	50.8	2.63	66.7	0.750	0.750	19.1	19.1	2,800	193	2,800	193	1,600	110	9,000	620	8,000	551
PG2(SWM2/S316L)-125	0.125	3.18	2.00	50.8	2.63	66.7	0.750	0.750	19.1	19.1	2,800	193	2,800	193	1,600	110	9,000	620	8,000	551
PG2(SWM2/S316L)-187	0.187	4.75	2.00	50.8	2.63	66.7	0.750	0.750	19.1	19.1	2,000	138	4,500	310	1,600	110	8,800	606	4,000	276
PG2(SWM2/S316L)-236	0.236	5.99	2.00	50.8	2.63	66.7	0.750	0.750	19.1	19.1	1,800	124	3,000	207	1,200	83	7,500	517	4,000	276
PG2(SWM2/S316L)-250	0.250	6.35	2.00	50.8	2.63	66.7	0.750	0.750	19.1	19.1	1,600	110	2,000	138	800	55	7,500	517	4,000	276
SAE 7/16-20 Thread Mount (formerly MS)																				
PG2(MSE4)-BLANK	NA	NA	2.00	50.8	2.63	66.7	0.750	0.750	19.1	19.1	NA	NA	NA	NA	NA	NA	NA	NA	NA	NA
PG2(MSE4)-125	0.125	3.18	2.00	50.8	2.63	66.7	0.750	0.750	19.1	19.1	2,800	193	2,800	193	1,600	110	9,000	620	8,000	551
SAE 1/2-20 Thread Mount (formerly MS)																				
PG2(MSE5)-BLANK	NA	NA	2.00	50.8	2.63	66.7	0.750	0.750	19.1	19.1	NA	NA	NA	NA	NA	NA	NA	NA	NA	NA
PG2(MSE5)-187	0.187	4.75	2.00	50.8	2.63	66.7	0.750	0.750	19.1	19.1	2,000	138	4,500	310	1,600	110	8,800	606	4,000	276
SAE 9/16-18 Thread Mount (formerly MS)																				
PG2(MSE6)-BLANK	NA	NA	2.00	50.8	2.63	66.7	0.750	0.750	19.1	19.1	NA	NA	NA	NA	NA	NA	NA	NA	NA	NA
PG2(MSE6)-250	0.250	6.35	2.00	50.8	2.63	66.7	0.750	0.750	19.1	19.1	1,600	110	2,000	138	800	55	7,500	517	4,000	276
BORE SIZES 0.187 TO 0.375 (1/8 PIPE) - MODEL PG4																				
Standard 1/2 NPT																				
PG4-BLANK	NA	NA	2.56	65.0	3.31	84.1	1.000	1.000	25.4	25.4	NA	NA	NA	NA	NA	NA	NA	NA	NA	NA
PG4-187	0.187	4.75	2.56	65.0	3.31	84.1	1.000	1.000	25.4	25.4	1,500	103	1,500	103	2,400	165	10,000	689	8,000	551
PG4-236	0.236	5.99	2.56	65.0	3.31	84.1	1.000	1.000	25.4	25.4	1,500	103	1,500	103	1,600	110	10,000	689	7,500	517
PG4-250	0.250	6.35	2.56	65.0	3.31	84.1	1.000	1.000	25.4	25.4	1,500	103	1,500	103	1,600	110	10,000	689	7,500	517
PG4-312	0.312	7.92	2.56	65.0	3.31	84.1	1.000	1.000	25.4	25.4	1,200	83	1,200	83	2,000	138	10,000	689	7,000	482
PG4-375	0.375	9.53	2.56	65.0	3.31	84.1	1.000	1.000	25.4	25.4	1,200	83	500	34	1,400	96	7,500	517	4,500	310
PG4-12P	0.405	10.29	2.56	65.0	3.31	84.1	1.000	1.000	25.4	25.4	C/F	C/F	C/F	C/F	C/F	C/F	C/F	C/F	C/F	C/F

C/F = Consult factory. NA = Not Applicable.

All pressure and torque ratings were determined at 68° F (20° C) using stainless steel rod as the element. Pressure ratings may degrade at higher temperatures. Pressure rating guide values are provided for glands with elements restrained by the compressed sealant. Higher pressure may be attained with additional element restraints. Tolerance of tube or probe diameter is ±0.005 (±0.003 for diameters ≤0.040). Deviation from the nominal may affect pressure ratings. Standard O.D. tolerance of pipe is +0.015"/-0.031". Consult factory for details.

CAUTION: When sealing on soft, fragile or crushable elements, catalog torques may not apply. When catalog torques are applied, compressed sealants generate considerable forces on the element to be sealed. These forces could result in damaging soft or fragile elements such as coax cables or thin-wall materials. Consult factory for these types of applications.

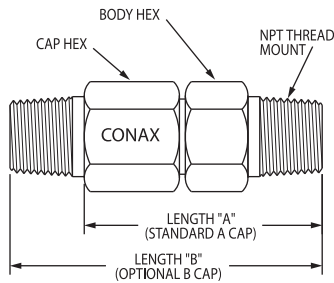

Standard NPT

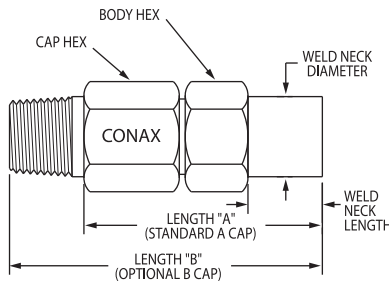

Weld Neck Mount

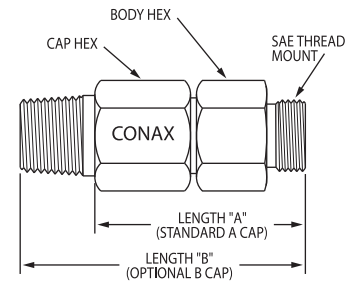

SAE Thread Mount

Catalog Number	Tube/Probe Diameter		Length 'A'				Length 'B'				Hex Size			Neoprene		Viton		PTFE		Lava		Grafoil		
	IN	MM	IN	MM	IN	MM	IN	MM	IN	MM	IN	MM	MM	PSIG	BAR	PSIG	BAR	PSIG	BAR	PSIG	BAR	PSIG	BAR	
BORE SIZES 0.187" TO 0.375" (1/8" PIPE) – MODEL PG4																								
PG4 with Optional 1/4 NPT																								
PG4(PTM2)-187	0.187	4.75	2.56	65.0	3.31	84.1	1.000	1.000	25.4	25.4	1,500	103	1,500	103	2,400	165	10,000	689	8,000	551				
PG4(PTM2)-236	0.236	5.99	2.56	65.0	3.31	84.1	1.000	1.000	25.4	25.4	1,500	103	1,500	103	1,600	110	10,000	689	7,500	517				
PG4(PTM2)-250	0.250	6.35	2.56	65.0	3.31	84.1	1.000	1.000	25.4	25.4	1,500	103	1,500	103	1,600	110	10,000	689	7,500	517				
PG4(PTM2)-312	0.312	7.92	2.56	65.0	3.31	84.1	1.000	1.000	25.4	25.4	1,200	83	1,200	83	2,000	138	10,000	689	7,000	482				
PG4(PTM2)-375	0.375	9.53	2.56	65.0	3.31	84.1	1.000	1.000	25.4	25.4	1,200	83	500	34	1,400	96	7,500	517	4,500	310				
PG4 with Optional 3/8 NPT																								
PG4(PTM3)-187	0.187	4.75	2.56	65.0	3.31	84.1	1.000	1.000	25.4	25.4	1,500	103	1,500	103	2,400	165	10,000	689	8,000	551				
PG4(PTM3)-236	0.236	5.99	2.56	65.0	3.31	84.1	1.000	1.000	25.4	25.4	1,500	103	1,500	103	1,600	110	10,000	689	7,500	517				
PG4(PTM3)-250	0.250	6.35	2.56	65.0	3.31	84.1	1.000	1.000	25.4	25.4	1,500	103	1,500	103	1,600	110	10,000	689	7,500	517				
PG4(PTM3)-312	0.312	7.92	2.56	65.0	3.31	84.1	1.000	1.000	25.4	25.4	1,200	83	1,200	83	2,000	138	10,000	689	7,000	482				
PG4(PTM3)-375	0.375	9.53	2.56	65.0	3.31	84.1	1.000	1.000	25.4	25.4	1,200	83	500	34	1,400	96	7,500	517	4,500	310				
PG4 with Optional 3/4 NPT																								
PG4(PTM5)-187	0.187	4.75	2.56	65.0	3.31	84.1	1.250	1.000	31.8	25.4	1,500	103	1,500	103	2,400	165	10,000	689	8,000	551				
PG4(PTM5)-236	0.236	5.99	2.56	65.0	3.31	84.1	1.250	1.000	31.8	25.4	1,500	103	1,500	103	1,600	110	10,000	689	7,500	517				
PG4(PTM5)-250	0.250	6.35	2.56	65.0	3.31	84.1	1.250	1.000	31.8	25.4	1,500	103	1,500	103	1,600	110	10,000	689	7,500	517				
PG4(PTM5)-312	0.312	7.92	2.56	65.0	3.31	84.1	1.250	1.000	31.8	25.4	1,200	83	1,200	83	2,000	138	10,000	689	7,000	482				
PG4(PTM5)-375	0.375	9.53	2.56	65.0	3.31	84.1	1.250	1.000	31.8	25.4	1,200	83	500	34	1,400	96	7,500	517	4,500	310				
Weld Neck Mount (Weld Neck Length 0.78", Diameter 0.84")**																								
PG4(SWM4/S316L)-BLANK	NA	NA	2.56	65.0	3.31	84.1	1.000	1.000	25.4	25.4	NA	NA	NA	NA	NA	NA	NA	NA	NA	NA	NA	NA	NA	NA
PG4(SWM4/S316L)-187	0.187	4.75	2.56	65.0	3.31	84.1	1.000	1.000	25.4	25.4	1,500	103	1,500	103	2,400	165	10,000	689	8,000	551				
PG4(SWM4/S316L)-236	0.236	5.99	2.56	65.0	3.31	84.1	1.000	1.000	25.4	25.4	1,500	103	1,500	103	1,600	110	10,000	689	7,500	517				
PG4(SWM4/S316L)-250	0.250	6.35	2.56	65.0	3.31	84.1	1.000	1.000	25.4	25.4	1,500	103	1,500	103	1,600	110	10,000	689	7,500	517				
PG4(SWM4/S316L)-312	0.312	7.92	2.56	65.0	3.31	84.1	1.000	1.000	25.4	25.4	1,200	83	1,200	83	2,000	138	10,000	689	7,000	482				
PG4(SWM4/S316L)-375	0.375	9.53	2.56	65.0	3.31	84.1	1.000	1.000	25.4	25.4	1,200	83	500	34	1,400	96	7,500	517	4,500	310				
PG4(SWM4/S316L)-12P	0.405	10.29	2.56	65.0	3.31	84.1	1.000	1.000	25.4	25.4	C/F	C/F	C/F	C/F	C/F	C/F	C/F	C/F	C/F	C/F	C/F	C/F	C/F	C/F
SAE 1/2-20 Thread Mount (formerly MS)																								
PG4(MSE5)-BLANK	NA	NA	2.56	65.0	3.31	84.1	1.000	1.000	25.4	25.4	NA	NA	NA	NA	NA	NA	NA	NA	NA	NA	NA	NA	NA	NA
PG4(MSE5)-187	0.187	4.75	2.56	65.0	3.31	84.1	1.000	1.000	25.4	25.4	1,500	103	1,500	103	2,400	165	9,138	630	8,000	551				
SAE 9/16-18 Thread Mount (formerly MS)																								
PG4(MSE6)-BLANK	NA	NA	2.56	65.0	3.31	84.1	1.000	1.000	25.4	25.4	NA	NA	NA	NA	NA	NA	NA	NA	NA	NA	NA	NA	NA	NA
PG4(MSE6)-250	0.250	6.35	2.56	65.0	3.31	84.1	1.000	1.000	25.4	25.4	1,500	103	1,500	103	1,600	110	9,138	630	7,500	517				
SAE 3/4-16 Thread Mount (formerly MS)																								
PG4(MSE8)-BLANK	NA	NA	2.56	65.0	3.31	84.1	1.000	1.000	25.4	25.4	NA	NA	NA	NA	NA	NA	NA	NA	NA	NA	NA	NA	NA	NA
PG4(MSE8)-312	0.312	7.92	2.56	65.0	3.31	84.1	1.000	1.000	25.4	25.4	1,200	83	1,200	83	2,000	138	9,138	630	7,000	482				
PG4(MSE8)-375	0.375	9.53	2.56	65.0	3.31	84.1	1.000	1.000	25.4	25.4	1,200	83	500	34	1,400	96	7,500	517	4,500	310				

Note: the pressure and torque ratings provided in this catalog apply only when bores are drilled by Conax Technologies.

* Hex size for the body and cap are the same unless a cap size is provided in parentheses. Blanks are provided with no hole in the body, follower and sealant.

** Weld neck models require lubrication prior to use.

N/O = Not Offered, NA = Not Applicable

5001D

SINGLE ELEMENT SEALING – SPECIFICATIONS ■ PG SERIES

Catalog Number	Tube/Probe Diameter		Length 'A'		Length 'B'		Hex Size				Pressure Rating									
	IN	MM	IN	MM	IN	MM	Body IN	Cap IN	Body MM	Cap MM	Neoprene PSIG	Neoprene BAR	Viton PSIG	Viton BAR	PTFE PSIG	PTFE BAR	Lava PSIG	Lava BAR	Grafoil PSIG	Grafoil BAR
BORE SIZES 0.375" TO 0.75" (1/8" TO 3/8" PIPE) - MODEL PG5																				
Standard 3/4 NPT																				
PG5-BLANK	NA	NA	2.88	73.0	3.63	92.1	1.250	1.500	31.8	38.1	NA	NA	NA	NA	NA	NA	NA	NA	NA	NA
PG5-250	0.250	6.35	2.88	73.0	3.63	92.1	1.250	1.500	31.8	38.1	400	28	2,400	165	800	55	2,800	193	1,200	83
PG5-375	0.375	9.53	2.88	73.0	3.63	92.1	1.250	1.500	31.8	38.1	400	28	2,400	165	800	55	2,800	193	1,200	83
PG5-12P	0.405	10.29	2.88	73.0	3.63	92.1	1.250	1.500	31.8	38.1	C/F	C/F	C/F	C/F	C/F	C/F	C/F	C/F	C/F	C/F
PG5-500	0.500	12.70	2.88	73.0	3.63	92.1	1.250	1.500	31.8	38.1	800	55	1,200	83	800	55	2,000	138	1,200	83
PG5-25P	0.540	13.72	2.88	73.0	3.63	92.1	1.250	1.500	31.8	38.1	C/F	C/F	C/F	C/F	C/F	C/F	C/F	C/F	C/F	C/F
PG5-625	0.625	15.88	2.88	73.0	3.63	92.1	1.250	1.500	31.8	38.1	400	28	400	28	800	55	3,600	248	1,200	83
PG5-37P	0.675	17.15	2.88	73.0	3.63	92.1	1.250	1.500	31.8	38.1	C/F	C/F	C/F	C/F	C/F	C/F	C/F	C/F	C/F	C/F
PG5-750	0.750	19.05	2.88	73.0	3.63	92.1	1.250	1.500	31.8	38.1	400	28	400	28	400	28	2,800	193	1,200	83
PG5 with Optional 1/2 NPT																				
PG5(PTM4)-250	0.250	6.35	2.88	73.0	3.63	92.1	1.250	1.500	31.8	38.1	400	28	2,400	165	800	55	2,800	193	1,200	83
PG5(PTM4)-375	0.375	9.53	2.88	73.0	3.63	92.1	1.250	1.500	31.8	38.1	400	28	2,400	165	800	55	2,800	193	1,200	83
PG5(PTM4)-500	0.500	12.70	2.88	73.0	3.63	92.1	1.250	1.500	31.8	38.1	800	55	1,200	83	800	55	2,000	138	1,200	83
PG5(PTM4)-625	0.625	15.88	2.88	73.0	3.63	92.1	1.250	1.500	31.8	38.1	400	28	400	28	800	55	3,600	248	1,200	83
PG5 with Optional 1 NPT																				
PG5(PTM6)-250	0.250	6.35	3.12	79.2	3.87	98.3	1.500	1.500	38.1	38.1	400	28	2,400	165	800	55	2,800	193	1,200	83
PG5(PTM6)-375	0.375	9.53	3.12	79.2	3.87	98.3	1.500	1.500	38.1	38.1	400	28	2,400	165	800	55	2,800	193	1,200	83
PG5(PTM6)-500	0.500	12.70	3.12	79.2	3.87	98.3	1.500	1.500	38.1	38.1	800	55	1,200	83	800	55	2,000	138	1,200	83
PG5(PTM6)-625	0.625	15.88	3.12	79.2	3.87	98.3	1.500	1.500	38.1	38.1	400	28	400	28	800	55	3,600	248	1,200	83
PG5(PTM6)-750	0.750	19.05	3.12	79.2	3.87	98.3	1.500	1.500	38.1	38.1	400	28	400	28	400	28	2,800	193	1,200	83
Weld Neck Mount (Weld Neck Length 0.79", Diameter 1.050")**																				
PG5(SWM5/S316L)-BLANK	NA	NA	2.88	73.0	3.63	92.1	1.250	1.500	31.8	38.1	NA	NA	NA	NA	NA	NA	NA	NA	NA	NA
PG5(SWM5/S316L)-250	0.250	6.35	2.88	73.0	3.63	92.1	1.250	1.500	31.8	38.1	400	28	2,400	165	800	55	2,800	193	1,200	83
PG5(SWM5/S316L)-375	0.375	9.53	2.88	73.0	3.63	92.1	1.250	1.500	31.8	38.1	400	28	2,400	165	800	55	2,800	193	1,200	83
PG5(SWM5/S316L)-12P	0.405	10.29	2.88	73.0	3.63	92.1	1.250	1.500	31.8	38.1	C/F	C/F	C/F	C/F	C/F	C/F	C/F	C/F	C/F	C/F
PG5(SWM5/S316L)-500	0.500	12.70	2.88	73.0	3.63	92.1	1.250	1.500	31.8	38.1	800	55	1,200	83	800	55	2,000	138	1,200	83
PG5(SWM5/S316L)-25P	0.540	13.72	2.88	73.0	3.63	92.1	1.250	1.500	31.8	38.1	C/F	C/F	C/F	C/F	C/F	C/F	C/F	C/F	C/F	C/F
PG5(SWM5/S316L)-625	0.625	15.88	2.88	73.0	3.63	92.1	1.250	1.500	31.8	38.1	400	28	400	28	800	55	3,600	248	1,200	83
PG5(SWM5/S316L)-37P	0.675	17.15	2.88	73.0	3.63	92.1	1.250	1.500	31.8	38.1	C/F	C/F	C/F	C/F	C/F	C/F	C/F	C/F	C/F	C/F
PG5(SWM5/S316L)-750	0.750	19.05	2.88	73.0	3.63	92.1	1.250	1.500	31.8	38.1	400	28	400	28	400	28	2,800	193	1,200	83
SAE 9/16 -18 Thread Mount (formerly MS)																				
PG5(MSE6)-BLANK	NA	NA	2.88	73.0	3.63	92.1	1.250	1.500	31.8	38.1	NA	NA	NA	NA	NA	NA	NA	NA	NA	NA
PG5(MSE6)-250	0.250	6.35	2.88	73.0	3.63	92.1	1.250	1.500	31.8	38.1	400	28	2,400	165	800	55	2,800	193	1,200	83
SAE 3/4 -16 Thread Mount (formerly MS)																				
PG5(MSE8)-BLANK	NA	NA	2.88	73.0	3.63	92.1	1.250	1.500	31.8	38.1	NA	NA	NA	NA	NA	NA	NA	NA	NA	NA
PG5(MSE8)-375	0.375	9.53	2.88	73.0	3.63	92.1	1.250	1.500	31.8	38.1	400	28	2,400	165	800	55	2,800	193	1,200	83
SAE 1-1/16 -12 Thread Mount (formerly MS)																				
PG5(MSE12)-BLANK	NA	NA	2.88	73.0	3.63	92.1	1.375	1.500	34.9	38.1	NA	NA	NA	NA	NA	NA	NA	NA	NA	NA
PG5(MSE12)-500	0.500	12.70	2.88	73.0	3.63	92.1	1.375	1.500	34.9	38.1	800	55	1,200	83	800	55	2,000	138	1,200	83
SAE 1-5/16 -12 Thread Mount (formerly MS)																				
PG5(MSE16)-BLANK	NA	NA	2.88	73.0	3.63	92.1	1.625	1.500	41.3	38.1	NA	NA	NA	NA	NA	NA	NA	NA	NA	NA
PG5(MSE16)-625	0.625	15.88	2.88	73.0	3.63	92.1	1.625	1.500	41.3	38.1	400	28	400	28	800	55	3,600	248	1,200	83
PG5(MSE16)-750	0.750	19.05	2.88	73.0	3.63	92.1	1.625	1.500	41.3	38.1	400	28	400	28	400	28	2,800	193	1,200	83

C/F = Consult factory. NA = Not Applicable

All pressure and torque ratings were determined at 68° F (20° C) using stainless steel rod as the element. Pressure ratings may degrade at higher temperatures. Pressure rating guide values are provided for glands with elements restrained by the compressed sealant. Higher pressure may be attained with additional element restraints. Tolerance of tube or probe diameter is ±0.005. Deviation from the nominal may affect pressure ratings. Standard O.D. tolerance of pipe is +0.015"-0.031". Consult factory for details.

CAUTION: When sealing on soft, fragile or crushable elements, catalog torques may not apply. When catalog torques are applied, compressed sealants generate considerable forces on the element to be sealed. These forces could result in damaging soft or fragile elements such as coax cables or thin-wall materials. Consult factory for these types of applications.



Hex Style

Conax Technologies Large Bore PG Glands were designed to seal on pipe, tubes or probes with diameters of 0.750" or greater. Originally designed for applications such as liquid or gas sampling, coupon insertion and securing of commercial pipe, these glands generally operate at lower pressures than other PG glands. Their larger size and rugged design make them ideal for heavy duty industrial applications.

Model PG6 maintains the traditional hex style design. Model PG7 and up feature a flange cap design that provides ease of assembly and reduces the torque requirements that would be encountered with a hex design of that size. Threaded gland bodies, caps and followers are constructed from 303SST standard. Bodies constructed of 316LSST are standard for the weld neck models and available as an option on threaded glands.

Cap Style A offers a mounting thread only. Cap Style B provides threading on both ends for attachment to conduit or terminal heads.

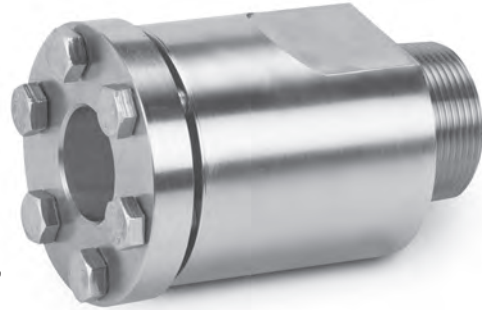

Flange Style

As always, custom materials, bore sizes and optional mounting configurations are available. Please consult a Conax Technologies' sales engineer for custom needs.

Accessories

The replaceable sealant permits repeated use of the same fitting. Assembly is simple and may be done in the field. Simply insert the element and torque the cap or cap screws. Large bore glands are offered with Viton, PTFE, Lava and Grafoil sealants. The Viton and PTFE sealants may be reused when the gland is loosened and retorqued. Grafoil offers limited reusability. Due to its composition, Lava is not reusable in these applications.

Glands are supplied factory lubricated. When reused, the glands should be relubricated to maintain the published torque and pressure ratings. If glands are cleaned prior to assembly, they should be relubricated. On weld mount models, the heat from the welding process will destroy the lubricant. These models must also be relubricated prior to use. See page 103 for information on our lubrication kit.

Catalog Numbering System

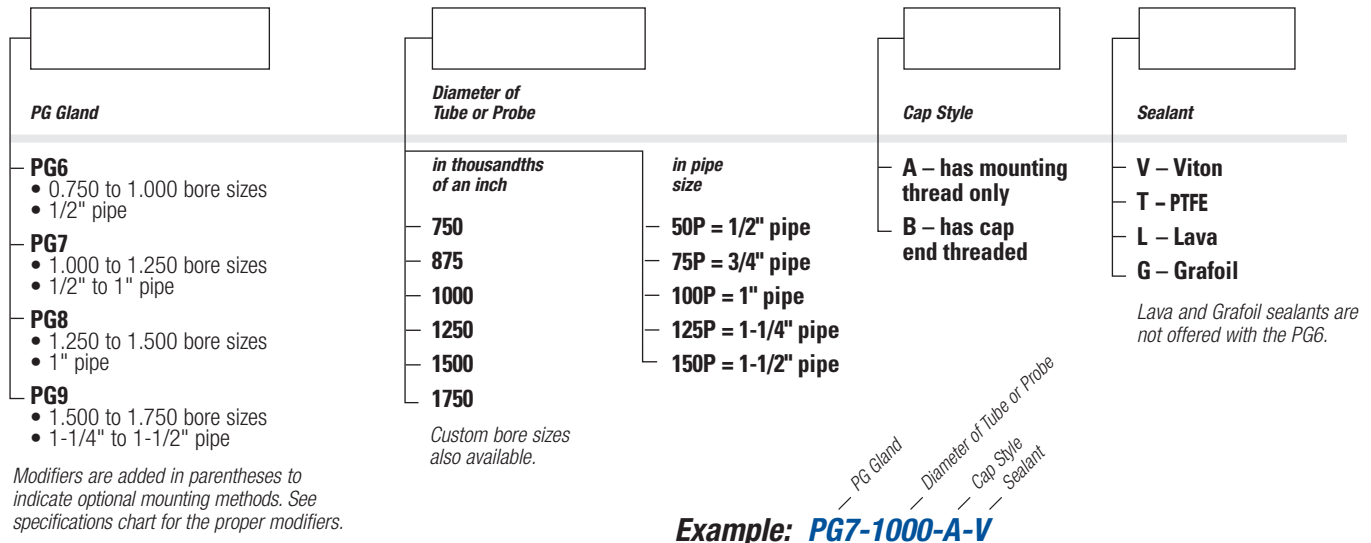

Modifiers are added in parentheses to indicate optional mounting methods. See specifications chart for the proper modifiers.

Hex Style

Catalog Number	Tube/Probe Diameter		Length 'A'		Length 'B'		Hex Size				Pressure Rating								
	IN	MM	IN	MM	IN	MM	Body	Cap	Body	Cap	Viton		PTFE		Lava		Grafoil		
							IN	IN	MM	MM	PSIG	BAR	PSIG	BAR	PSIG	BAR	PSIG	BAR	
MODEL PG6																			
Standard 1 NPT																			
PG6-750	0.750	19.05	3.50	88.9	4.50	114.3	1.750	2.000	44.5	50.8	1,000	69	400	28	NA	NA	NA	NA	
PG6-50P	0.840	21.34	3.50	88.9	4.50	114.3	1.750	2.000	44.5	50.8	1,000	69	400	28	NA	NA	NA	NA	
PG6-875	0.875	22.23	3.50	88.9	4.50	114.3	1.750	2.000	44.5	50.8	1,000	69	400	28	NA	NA	NA	NA	
PG6-1000	1.000	25.40	3.50	88.9	4.50	114.3	1.750	2.000	44.5	50.8	1,000	69	400	28	NA	NA	NA	NA	
Weld Neck Mount (Weld Neck Length 0.98", Diameter 1.315")**																			
PG6(SWM6/S316L)-750	0.750	19.05	3.50	88.9	4.50	114.3	1.750	2.000	44.5	50.8	1,000	69	400	28	NA	NA	NA	NA	
PG6(SWM6/S316L)-50P	0.840	21.34	3.50	88.9	4.50	114.3	1.750	2.000	44.5	50.8	1,000	69	400	28	NA	NA	NA	NA	
PG6(SWM6/S316L)-875	0.875	22.23	3.50	88.9	4.50	114.3	1.750	2.000	44.5	50.8	1,000	69	400	28	NA	NA	NA	NA	
PG6(SWM6/S316L)-1000	1.000	25.40	3.50	88.9	4.50	114.3	1.750	2.000	44.5	50.8	1,000	69	400	28	NA	NA	NA	NA	

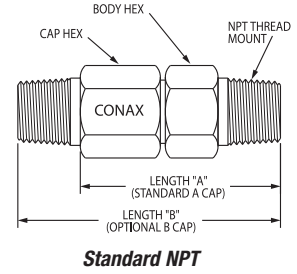

Flange Style

Catalog Number	Tube/Probe Diameter		Length 'A'		Length 'B'		Flange/Body Diameter		Pressure Rating										
	IN	MM	IN	MM	IN	MM	IN	MM	Viton		PTFE		Lava		Grafoil				
										PSIG	BAR	PSIG	BAR	PSIG	BAR	PSIG	BAR		
MODEL PG7																			
Standard 1-1/4 NPT																			
PG7-50P	0.840	21.34	3.75	95.3	5.00	127.0	3.000	76.2	1,000	69	C/F	C/F	500	34	750	52			
PG7-1000	1.000	25.40	3.75	95.3	5.00	127.0	3.000	76.2	1,000	69	C/F	C/F	500	34	750	52			
PG7-75P	1.050	26.67	3.75	95.3	NA	NA	3.000	76.2	1,000	69	C/F	C/F	500	34	750	52			
PG7-1250	1.250	31.75	3.75	95.3	NA	NA	3.000	76.2	1,000	69	C/F	C/F	500	34	750	52			
PG7-100P	1.315	33.40	3.75	95.3	NA	NA	3.000	76.2	1,000	69	C/F	C/F	500	34	750	52			
Weld Neck Mount (Weld Neck Length 1.01", Diameter 1.660")**																			
PG7(SWM7/S316L)-50P	0.840	21.34	3.75	95.3	5.00	127.0	3.000	76.2	1,000	69	C/F	C/F	500	34	750	52			
PG7(SWM7/S316L)-1000	1.000	25.40	3.75	95.3	5.00	127.0	3.000	76.2	1,000	69	C/F	C/F	500	34	750	52			
PG7(SWM7/S316L)-75P	1.050	26.67	3.75	95.3	NA	NA	3.000	76.2	1,000	69	C/F	C/F	500	34	750	52			
PG7(SWM7/S316L)-1250	1.250	31.75	3.75	95.3	NA	NA	3.000	76.2	1,000	69	C/F	C/F	500	34	750	52			
PG7(SWM7/S316L)-100P	1.315	33.40	3.75	95.3	NA	NA	3.000	76.2	1,000	69	C/F	C/F	500	34	750	52			
MODEL PG8																			
Standard 1-1/2 NPT																			
PG8-1250	1.250	31.75	4.25	108.0	NA	NA	4.000	101.6											
PG8-100P	1.315	33.40	4.25	108.0	NA	NA	4.000	101.6											
PG8-1500	1.500	38.10	4.25	108.0	NA	NA	4.000	101.6											
Weld Neck Mount (Weld Neck Length 1.03", Diameter 1.900")**																			
PG8(SWM8/S316L)-1250	1.250	31.75	4.25	108.0	NA	NA	4.000	101.6											
PG8(SWM8/S316L)-100P	1.315	33.40	4.25	108.0	NA	NA	4.000	101.6											
PG8(SWM8/S316L)-1500	1.500	38.10	4.25	108.0	NA	NA	4.000	101.6											
MODEL PG9																			
Standard 2 NPT																			
PG9-1500	1.500	38.10	5.06	128.6	NA	NA	5.000	127.0											
PG9-125P	1.660	42.16	5.06	128.6	NA	NA	5.000	127.0											
PG9-1750	1.750	44.45	5.06	128.6	NA	NA	5.000	127.0											
PG9-150P	1.900	48.26	5.06	128.6	NA	NA	5.000	127.0											
Weld Neck Mount (Weld Neck Length 1.06", Diameter 2.375")**																			
PG9(SWM9/S316L)-1500	1.500	38.10	5.06	128.6	NA	NA	5.000	127.0											
PG9(SWM9/S316L)-125P	1.660	42.16	5.06	128.6	NA	NA	5.000	127.0											
PG9(SWM9/S316L)-1750	1.750	44.45	5.06	128.6	NA	NA	5.000	127.0											
PG9(SWM9/S316L)-150P	1.900	48.26	5.06	128.6	NA	NA	5.000	127.0											

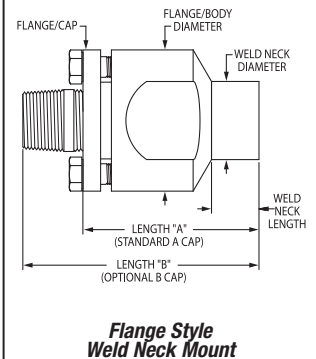
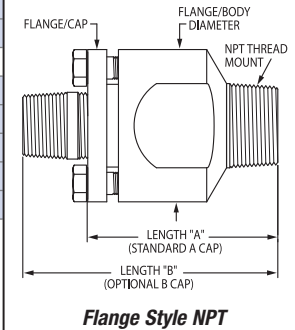
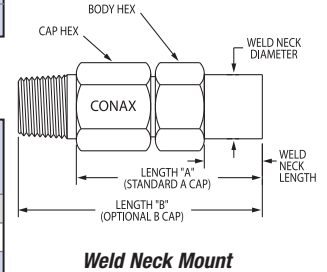

Pressure ratings on large bore models may be influenced by numerous factors and are therefore application specific. Please consult the factory for details.

Note: the pressure and torque ratings provided in this catalog apply only when bores are drilled by Conax Technologies.

* Hex size for the body and cap are the same unless a cap size is provided in parentheses.

** Weld neck models require lubrication prior to use.

N/O = Not Offered. C/F = Consult factory. NA = Not Available.

All pressure and torque ratings were determined at 68° F (20° C) using stainless steel rod as the element. Pressure ratings may degrade at higher temperatures. Pressure rating guide values are provided for glands with elements restrained by the compressed sealant. Higher pressure may be attained with additional element restraints. Tolerance of tube or probe diameter is ±0.005. Deviation from the nominal may affect pressure ratings. Standard O.D. tolerance of pipe is +0.015"/-0.031". Consult factory for details.

For proper assembly of these sealing glands, see the Assembly Instructions provided on pages 106-119.